

Držák čelní frézy MAS-BT 50, Ø 32 x 100

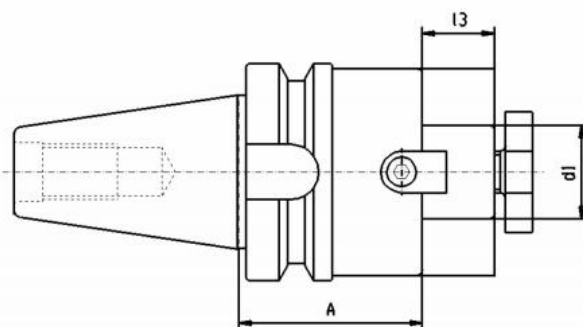

Kód produktu: 13-7388-50-32-100
EAN: 4049794019139
Celní tarif: 8466 1038
Hmotnost: 5,60 kg
Dostupnost: skladem

1 838,84 Kč bez DPH
~~2 775,00 Kč~~ **2 225,00 Kč s DPH**
73,55 € bez DPH
~~111,00 €~~ **89,00 € s DPH**

Parametry

A	100	D	32	L1	24
Velikost	MAS-BT 50	Wuchtgüte	G 6,3/ 15.000		

Tento produkt najdete v našem [KATALOGU na straně 230 \(2021\)](#)